



Crown XCL
HPL desky
pro venkovní použití







Elegance
se setkala
s trvanlivostí.



Crown Laminate je inovativní a všestranné řešení pro fasádní opláštění, které zlepšuje vzhled, výkonnost a dlouhověkost každé budovy.

HPL desky CrownXCL se vyrábějí v termosetovém lisu při vysokých teplotách a tlacích. Přidání dvakrát vytvrzované akrylové PUR pryskyřice dále zvyšuje trvanlivost panelů. V důsledku toho jsou panely CrownXCL extrémně

odolné a účinně chrání proti povětrnostním vlivům a UV záření. CrownXCL plní severoamerické požární standardy a je odolný proti nárazu i poškrábání. Tato odolnost umožňuje aplikaci CrownXCL v různých exteriérech,

jako jsou fasádní obklady, balkóny, venkovní nábytek, stropy, ploty a další. Panely CrownXCL se snadno montují, instalují a udržují a nabízejí širokou škálu designových možností.



Odolný vůči ohni



Snadná instalace



Snadné čištění



Odolává nárazům



Dvakrát vytvrzované



Anti-graffiti



Včetně UV ochrany



Nepromokavé a odolné vůči vodě



Odolné proti poškrábání



Vylepšuje zvukovou izolaci



CrownXCL Oplocení

Díky prakticky neomezeným možnostem designu můžete použít svou představivost k vytvoření plotu, který je architektonicky příjemný a zachová si svou původní krásu po mnoho dalších let.

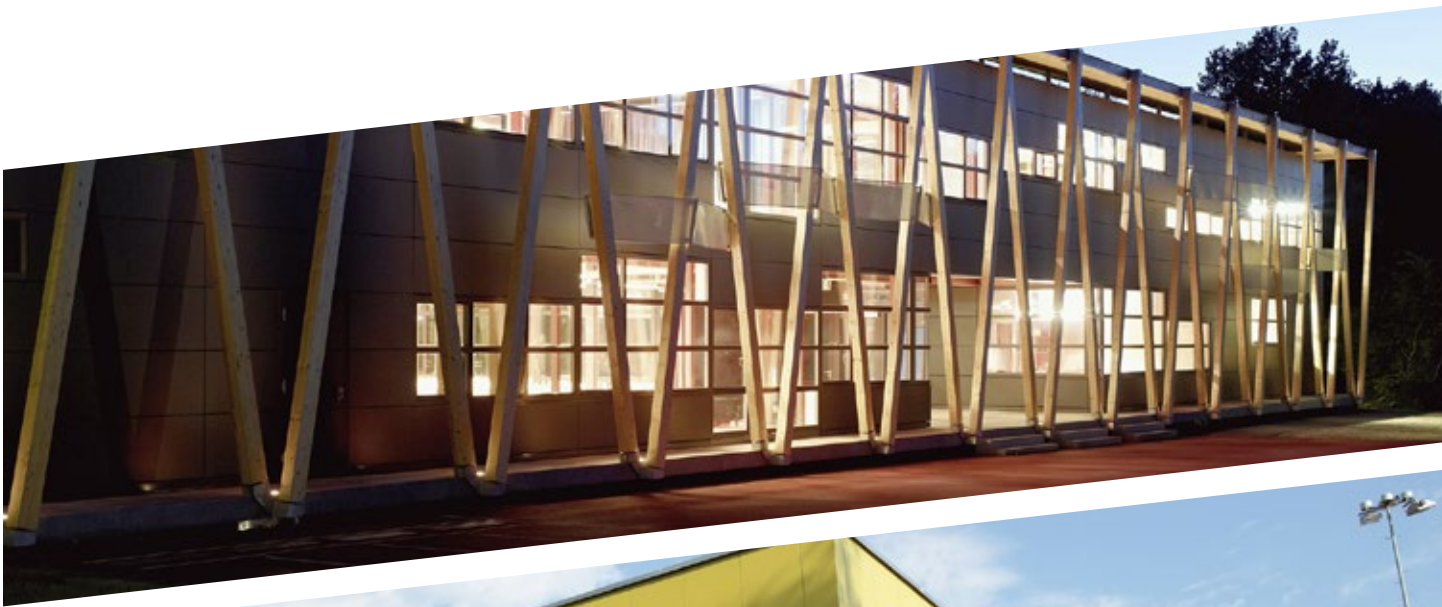

CrownXCL: ohleduplnot vůči životnímu prostředí

Papír používaný k výrobě CrownXCL je vyroben ze surovin pocházejících z udržitelných lesů.

Naše panely jsou vyrobeny z 80% z celulóзовých vláken získaných z udržitelných zdrojů a z 20% z termosetových pryskyřic. CrownXCL neobsahují žádné těžké kovy ani azbest. Neemitují také žádné plyny, výpary, rozpouštědla či kapaliny. Výsledkem je, že panely CrownXCL nemají negativní vliv na znečišťování životního prostředí. Panely CrownXCL byly nezávisle testovány a vyhověly několika environmentálním certifikacím včetně certifikace Greenguard Gold a certifikace Intertek Green Leaf.



Exterier

ROZMĚRY *

A 1220 x 2440 mm

B 1220 x 3050 mm

C 1300 x 3050 mm

TLOUŠTKY *

6, 8, 10, nebo 13 mm

DEKOR

Oboustranný

POVRCH

Polomatný s jemnou strukturou

Pozn.: Povrchy dle přání
na dotaz.

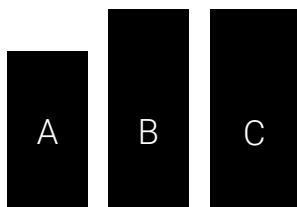

6 mm

8 mm

10 mm

13 mm

* Nominální



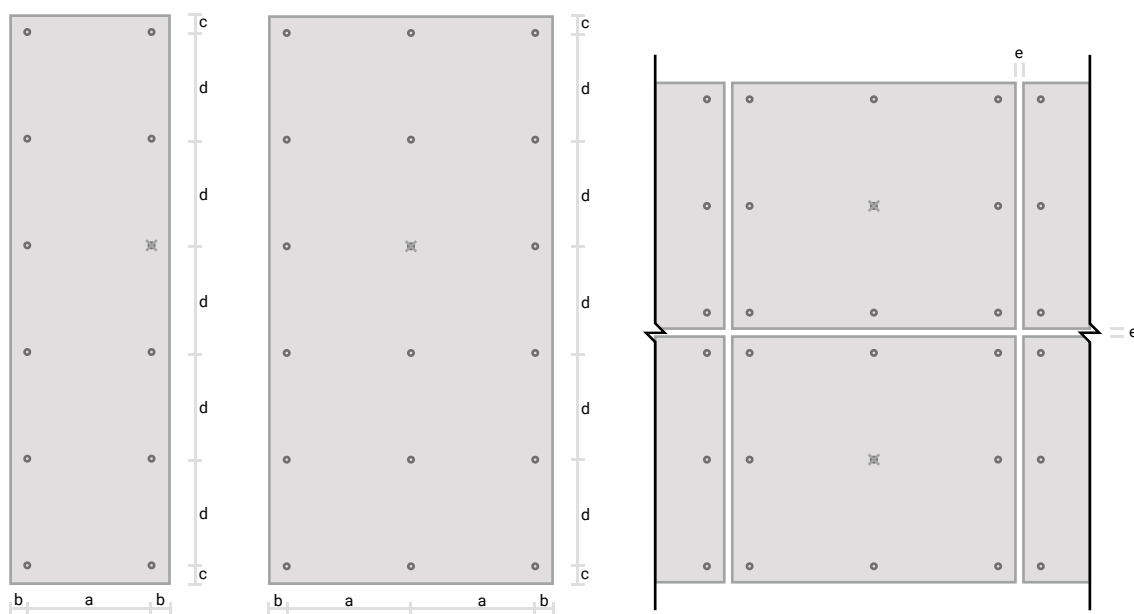

✕ Představuje pevný bod.

Výše uvedená schémata ukazují optimální prostor mezi spojovacími prvky a okrajem panelu. Zobrazují také optimální rozestup mezi jednotlivými panely. Jedná se o jedno z řešení, které je možné v závislosti na projektu vhodně změnit.

Tloušťka panelu*	Maximální rozestup šroubů (a) *	Minimální vzdálenost od hrany (b, c) *	Maximální rozestup šroubů(d) *	Dilatační mezera (e) *
6 mm	450 mm	50, 20 mm	550 mm	6-10 mm
8 mm	600 mm	50, 20 mm	750 mm	6-10 mm
10 mm	750 mm	50, 20 mm	900 mm	6-10 mm

* Nominální

Technické parametry

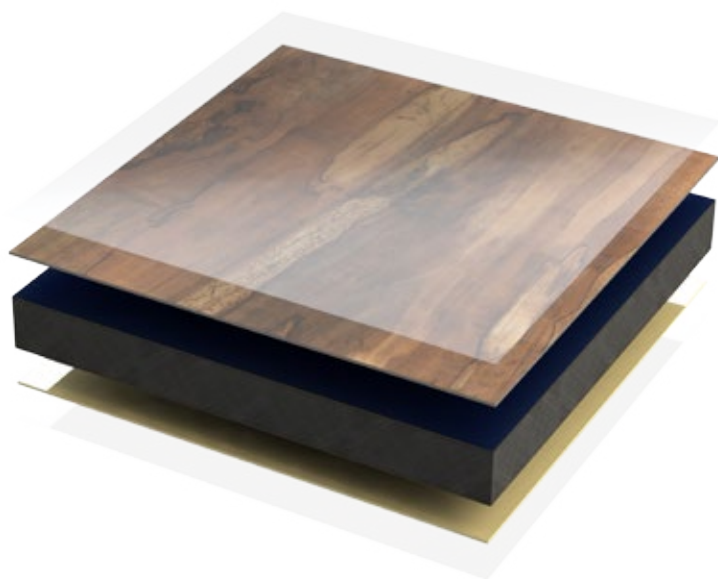

Vlastnosti

Parametr	Standardní hodnota	Hodnota CrownXCL
Hustota	1.35 g/cm ³	1.45 g/cm ³
Pevnost v ohybu	80 N/mm ²	114 N/mm ²
Modul pružnosti	9000 N/mm ²	13966 N/mm ²
Pevnost v tahu	60 N/mm ²	66 N/mm ²
Rozměrová stabilita při zvýšené teplotě	Podélně: 0.40% Příčně: 0.80%	Podélně: 0.25% Příčně: 0.40%
Umělé zvětvávání	Šedá stupnice: hodnota 3 Vzhled: hodnota 4	Šedá stupnice: hodnota 4 Vzhled: hodnota 4
Odolnost proti UV záření	Šedá stupnice: hodnota 3 Vzhled: hodnota 4	Šedá stupnice: hodnota 4 Vzhled: hodnota 4

Požární chování

Platné v	Testovací metoda	CrownXCL
Kanada	CAN/ULC S134	Vyhovuje
Evropa	CSN EN 13501-1+A1	B-s1, d0 (Vyhovuje)
USA	NFPA 285	Splňuje
Kanada + USA	ASTM E 84	Index šíření plamene: 10 Tvorba kouře: 0

Pro kompletní seznam testů a certifikací nás prosím kontaktujte.

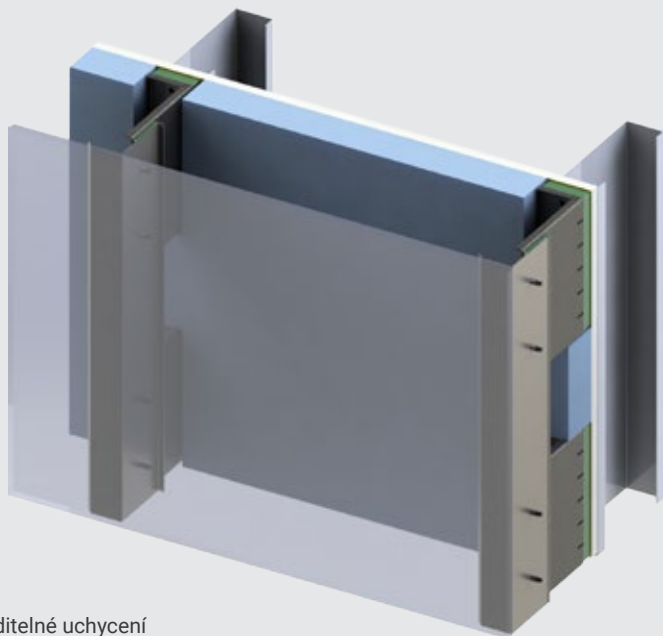

Viditelné uchycení

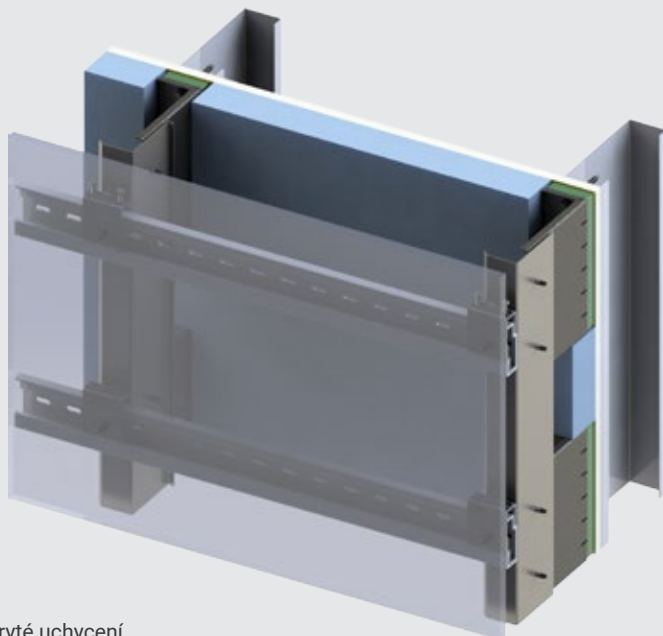

Skryté uchycení

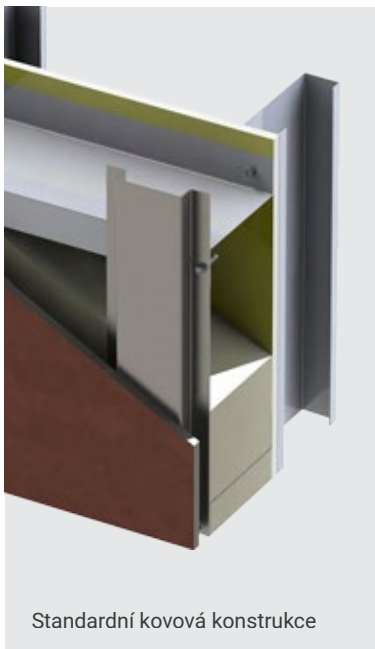

Standardní kovová konstrukce

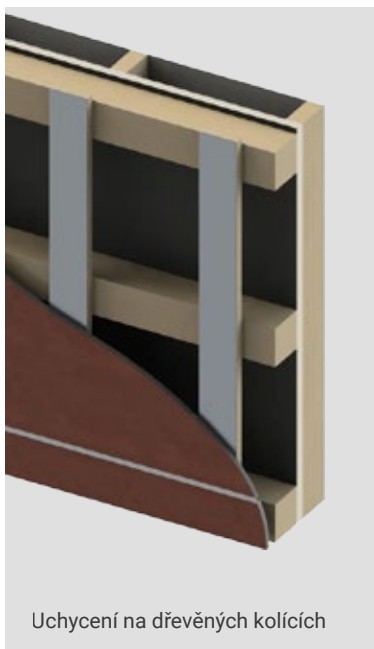

Uchycení na dřevěných kolících

MOŽNOSTI VYUŽITÍ V OBLASTI FASÁD

Rozmanité využití panelů CrownXCL zahrnuje jak provětrávané fasády, tak i fasády konvenční. Provětrávané fasády s použitím CrownXCL poskytují vysoký tepelný standard a to jak v létě, tak i v zimě, spolu s velice dlouhou životností, zejména díky eliminaci tvorby kondenzátů.

V případě potřeby dalších informací o aplikaci nebo zájmu o nabídku celého řešení včetně realizace nás, prosím, kontaktujete.

Alternativní systémy

CrownXCL funguje nejlépe ve spojení s provětrávanou fasádou, ale je možné použít i jiné techniky uchycení. Další informace o alternativních způsobech instalace vám rádi sdělíme osobně.

Plné barvy

#C851XL	#C856XL	#C13	#C611X
#C17X	#C855XL	#C608X	#860XL
#C10X	#C610XL	#C603XL	#C604XL
#C871XL	#T230	#T229	#C23X
#T221	#T220	#T215	#T235
#T1103	#C864XL	#T1107	#C872XL
#T187	#T218	#T214	#T216
#T201	#C867XL	#T212	#T232
#T217	#T1127	#T227	#C865XL
#T222	#T224	#C869XL	#C609X
#C605X	#T236	#C606X	#C11XL

Chcete-li zjistit dostupnost, prosím, kontaktujte nás.

Vzhledem k omezením interpretace barev při tisku nemusí být reprodukce přesná a před dokončením výběru barev se doporučuje provést kontrolu fyzického vzorku.

Textury

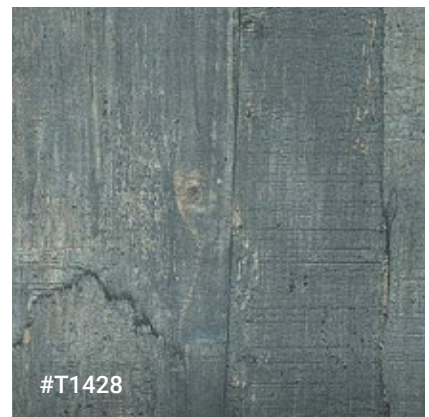
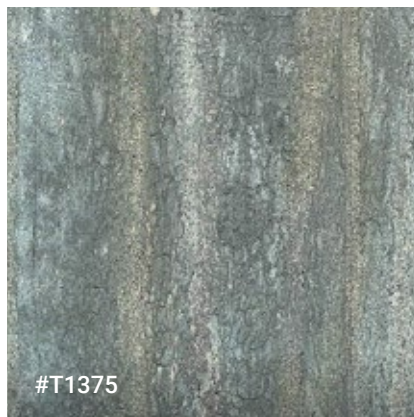
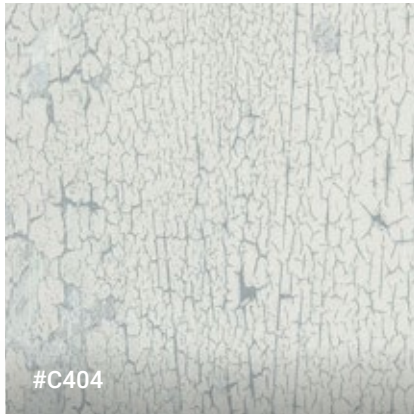

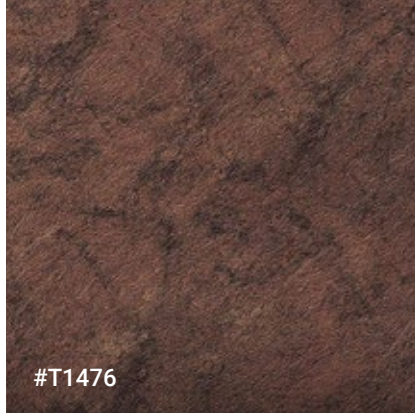
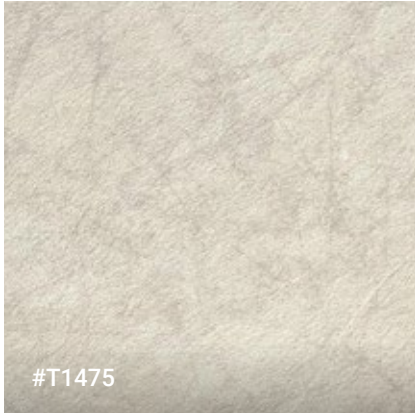



#C632X



#C631X



#C633X

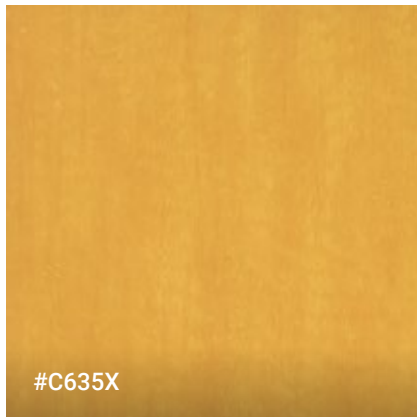

#C635X

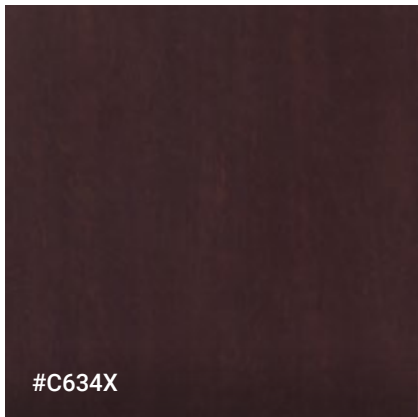

#C634X



#T1448

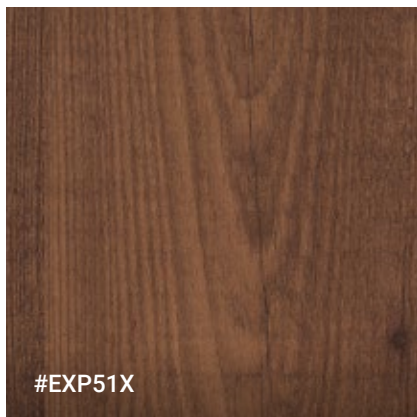

#EXP51X

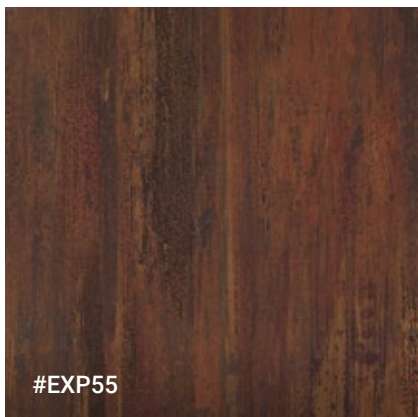

#EXP55



#C641X



#T1334



#T1335



#T1454

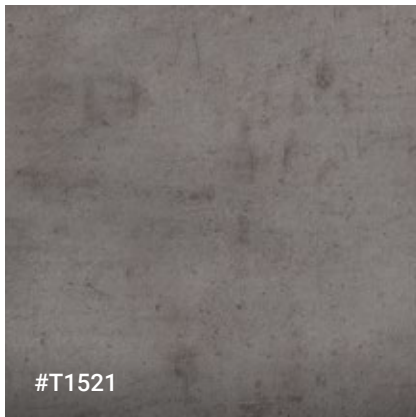

#T1521

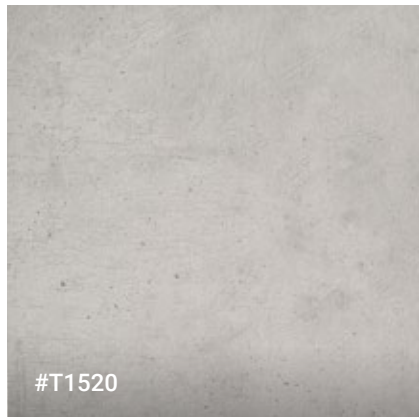

#T1520

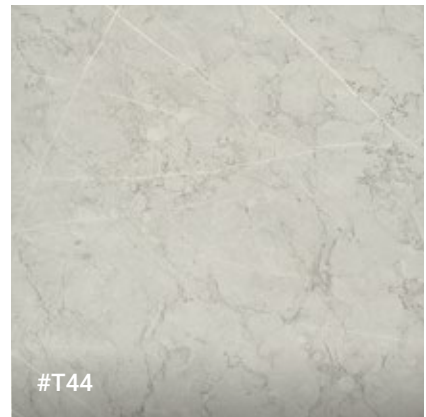

#T44



#T1329



#T1330



#T45



#T1432

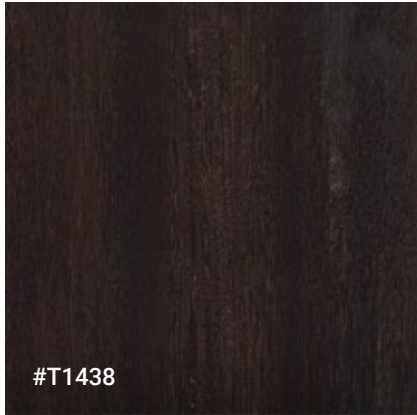

#T1438



#T1436

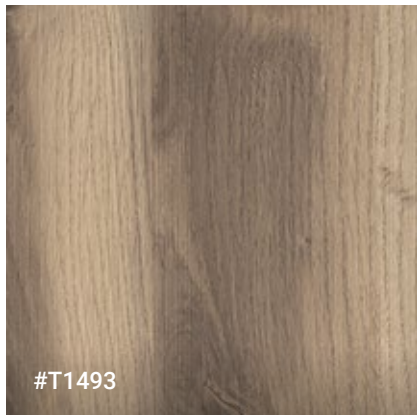

#T1493

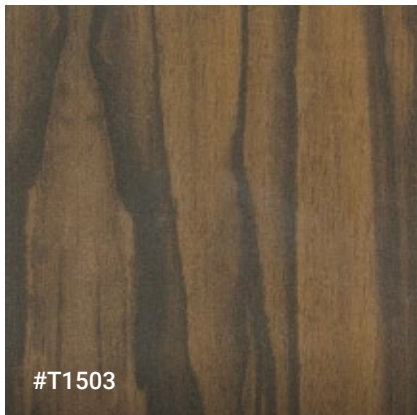

#T1503

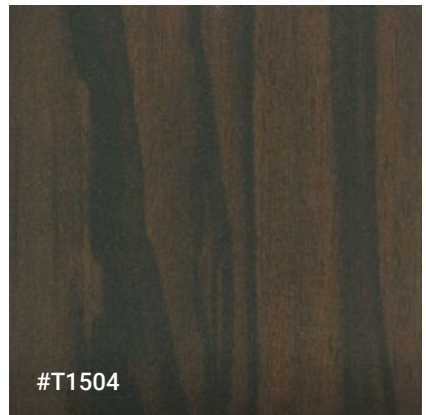

#T1504

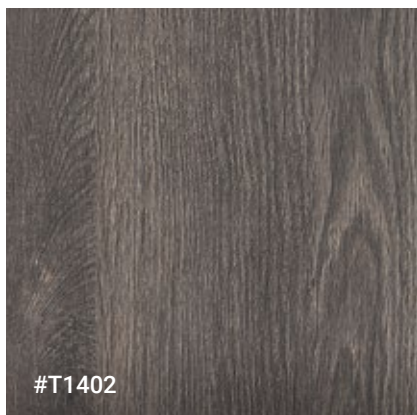

#T1402

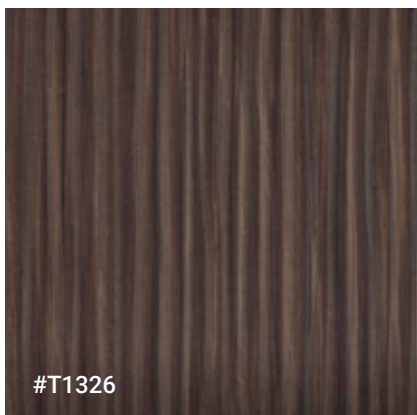

#T1326

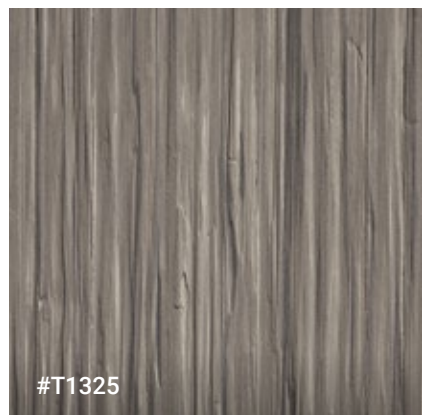

#T1325

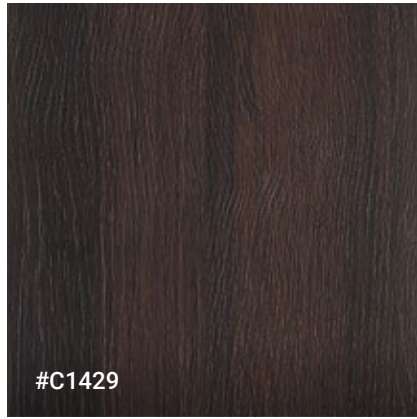
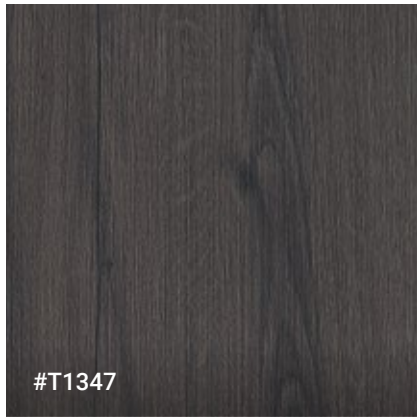
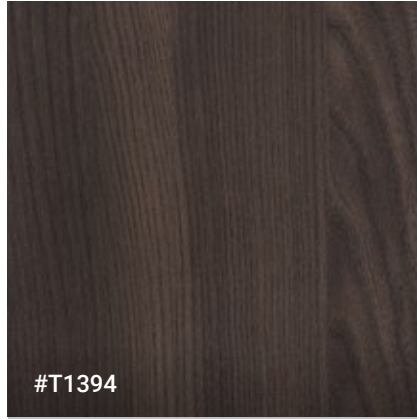
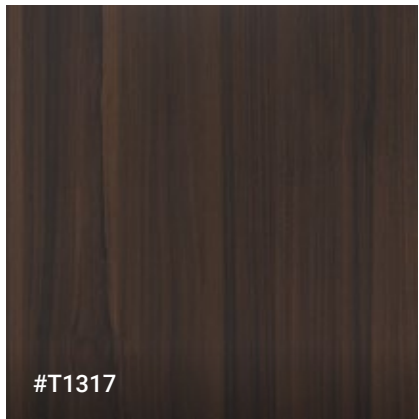
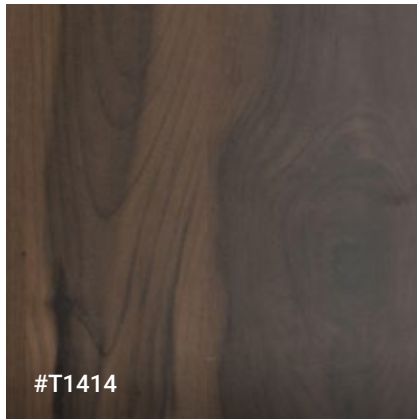
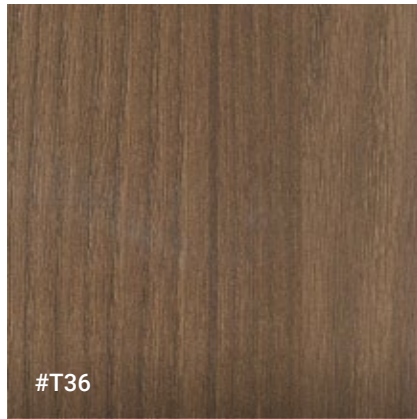
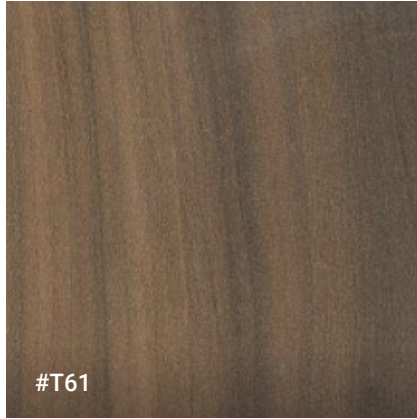

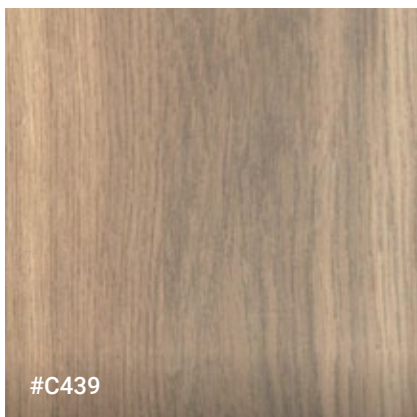
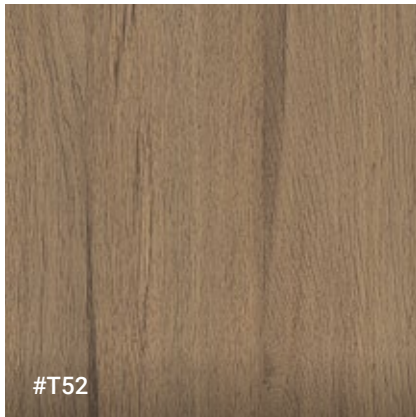
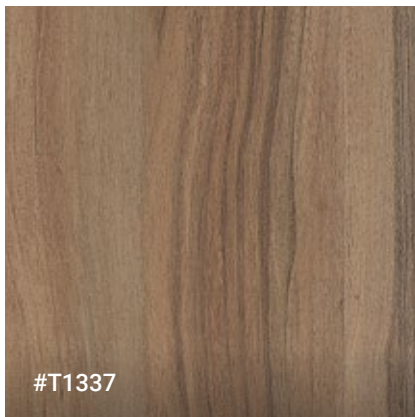
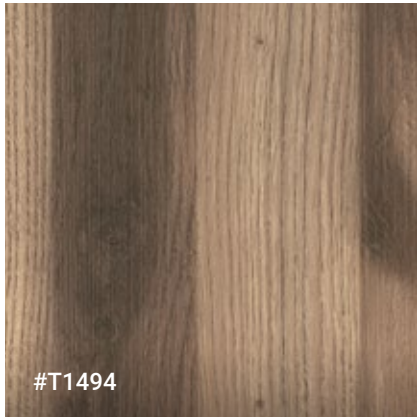
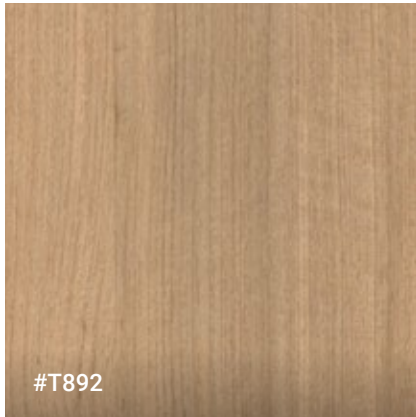

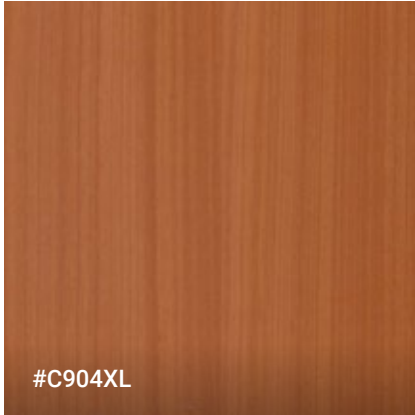

#C904XL

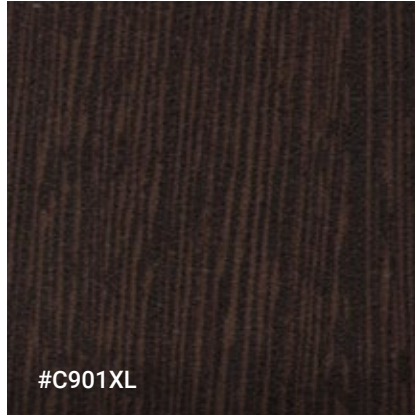

#C901XL

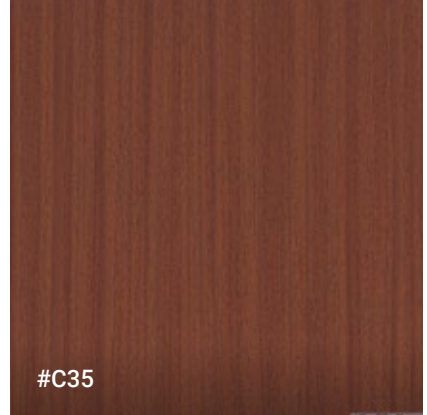

#C35

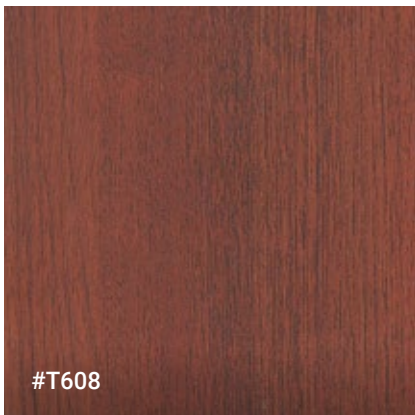

#T608

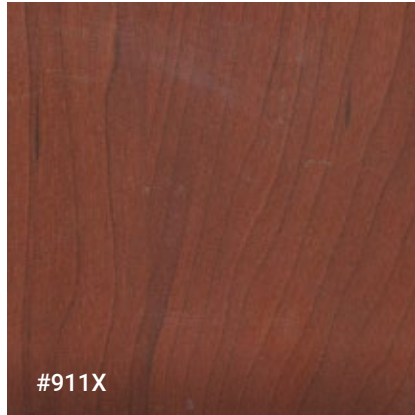

#911X

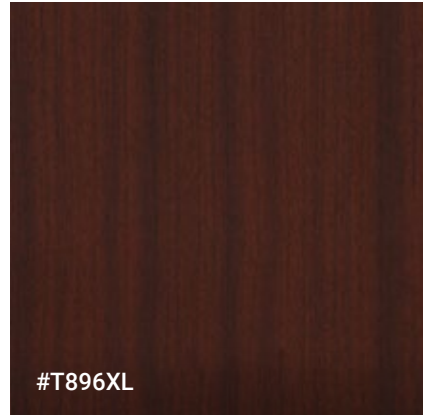

#T896XL



#T1407

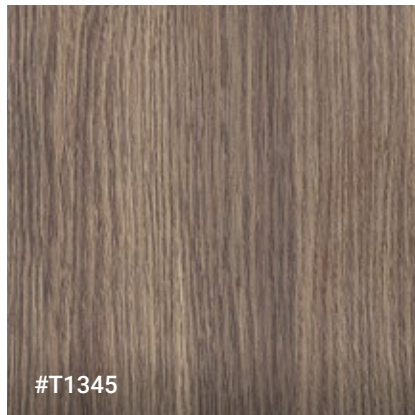

#T1345



#T1314



#C642XL

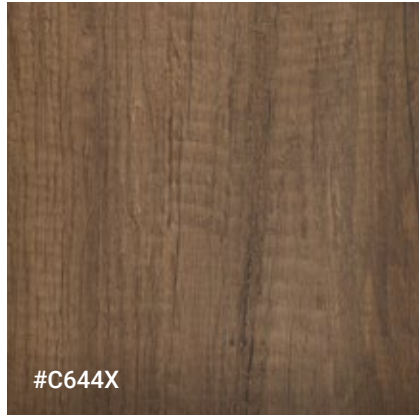

#C644X



#C639X



#T1431

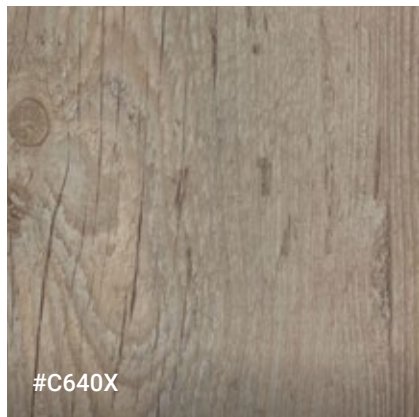

#C640X

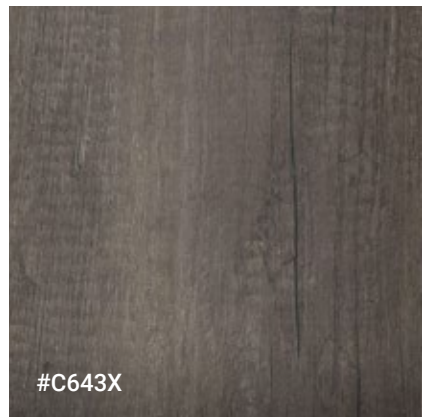

#C643X



#T1518

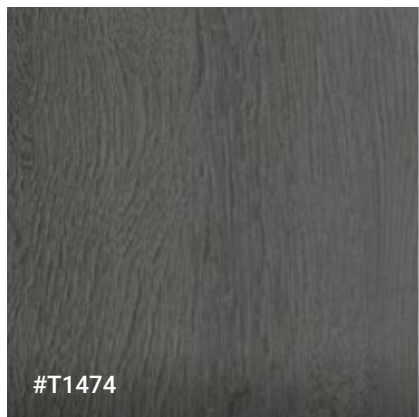

#T1474

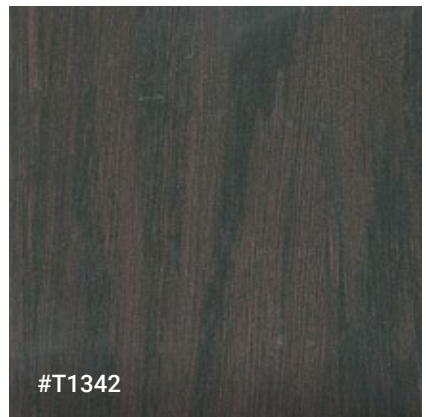

#T1342

